



GEBR. PFEIFFER



**PFEIFFER SOLUTIONS FOR
THE MINERAL INDUSTRIES**
VERSATILE. ECONOMICAL. RELIABLE.



GETTING IT DONE!

// Gebr. Pfeiffer supplies plant solutions that you can rely on 100 %. We only give our word if we know we can keep it. And we keep what we have promised. Extremely reliable, with excellent results for sustainable economic success. We have been technology drivers for over 155 years: pioneer of vertical roller mill technology, inventor of mill drives with more than 10,000 kW, modular ready2grind systems and gypsum calcination in vertical mills as well as an expert for innovative plant concepts in demand worldwide. With a strong team behind us. The best staff in all fields. All with a common goal: making possible what is needed. In Pfeiffer quality. **Getting it done - What can we do for you?**

5 good reasons to opt for Gebr. Pfeiffer

- » Machinery and plants that are worth the money
- » Knowledge and experience from the technology leader
- » Efficient and pragmatic solutions you can rely on
- » Excellent service worldwide
- » A strong international team in all domains



» We support you to get the best out of your material

// You want to build a new plant, make an existing one better and more efficient or create a completely new product? Pfeiffer is your partner for the entire mineral sector and all lime and quicklime products, prepared to tackle challenges. Offering intensive consulting and more than 100 years of experience in the industry. Ask our experts!

By opting for Gebr. Pfeiffer, you make sure you get:

- » **Grinding, drying, separating and hydrating** in Pfeiffer quality
- » **Products and process knowledge** for the optimum solutions
- » **Comprehensive consulting competence** due to our own test station and manufacturing facilities
- » **Extremely robust machinery** with high reliability and long lifetime
- » **Personal service directly from the manufacturer** with branches all over the world
- » **Reliable and fast procurement of spare parts** over decades and interesting service contracts



You are looking for a smart and future-proof investment?

// We supply sustainable products that are profitable for you for an extremely long time - from individual machines for upgrading or expanding existing plants to complete production plants. Spare parts will be available for many years and long-term support is provided. For a machine's entire life.



You want to save on energy and improve emissions?

// We make suggestions for adjustment, fine tuning and process optimization, show you when a vertical roller mill is the more efficient alternative to a ball mill, develop the appropriate solution that meets all new environmental requirements as economically as possible, and help you, for example, with the conversion to state-of-the-art dedusting technology.



You want to get the best out of your material and expand?

// We accompany you throughout the entire project, develop new products with you and offer tailor-made plants that can be expanded according to your requirements. If desired, they can also be made to fit into existing buildings. We have a solution for everything.



You need a plant which is extremely flexible?

// With us you are well prepared, even when market requirements change. Pfeiffer machines and plants can be adapted very quickly and easily, if a different product is to be produced. Completely frictionless, even with different fineness degrees in the range of 10 - 100 µm or different particle size distributions.

» The entire process in Pfeiffer quality



Gravel plant



Quarry



Crusher



Fine
(about 0 - 4 mm)



Coarse
(about 0 - 100 mm)



Lime burning



The right plant for every task

// We combine our products individually according to your requirements. Thus, we offer, from a single source, the ideal solution for every task.

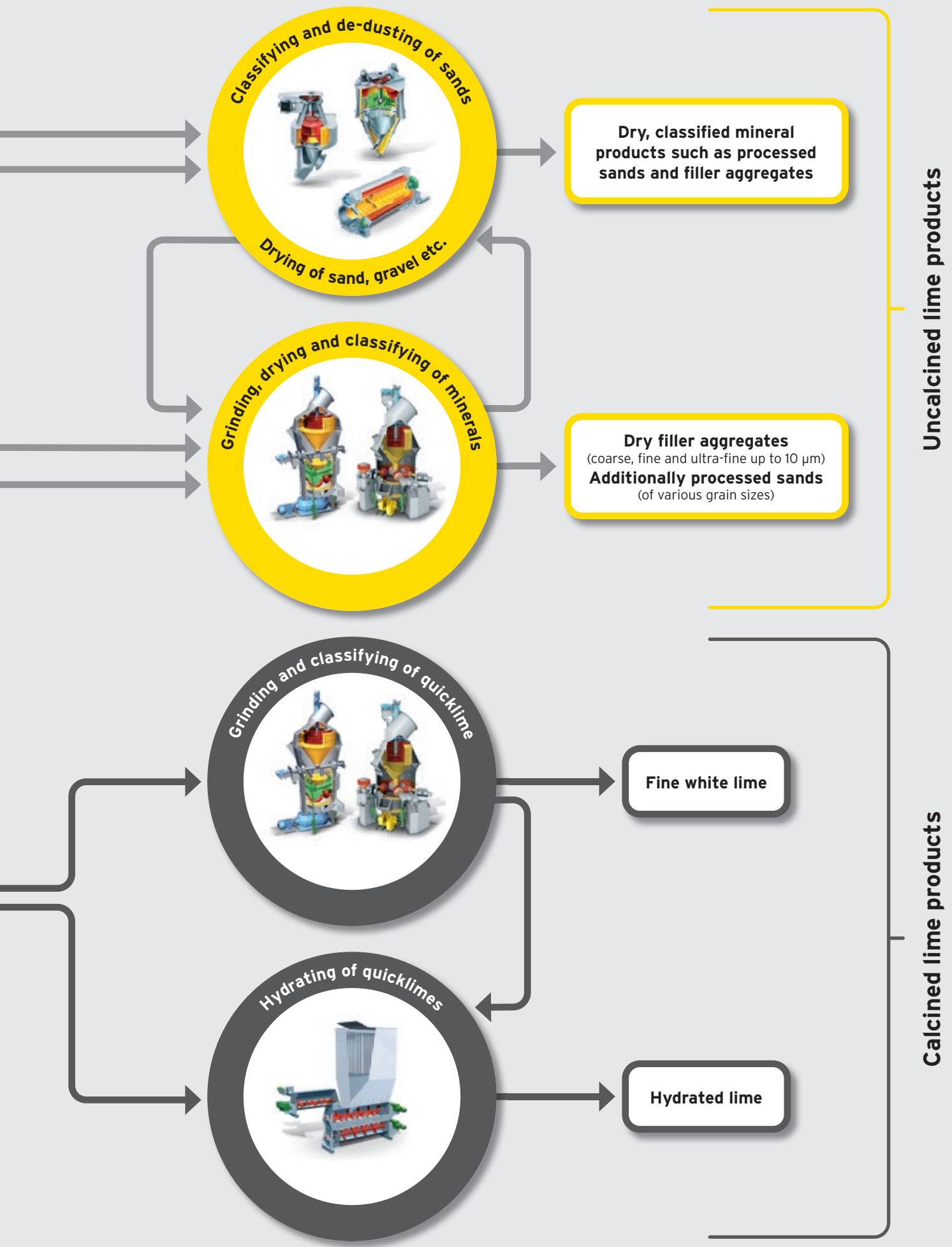

» Uncalcined mineral products - the efficient way to a dry processed product

// For the field of unburnt mineral products, Pfeiffer offers not only the classic combination of drying and downstream classifying, but also grinding, drying and classifying in one unit - a clear advantage of vertical mill technology. And thus the most energy-efficient system for producing the desired product with the required particle sizes and adapted particle size distribution.



Tailored grain size distributions

// You need reliably determined grain sizes and a grain size distribution exactly adapted to your product? Pfeiffer's solution: over 100 years of process know-how. We ensure the perfect interaction of grinding and classifying process. And thus make sure an exact top cut, if you need it.



Mineral processing to obtain artificial sands

// Natural sand becomes scarce. The globally booming construction industry needs this precious raw material in ever larger quantities. Artificially produced sands of limestone or other types of rock help to close the gap and conserve resources. Pfeiffer offers the necessary machinery for processing pre-crushed rock to obtain products for sale. And over 100 years of experience.



» Use Pfeiffer equipment to produce:

- » Processed sands
- » Filler aggregates
- » Fine aggregates



**Processing crushed sand
is profitable**

// Is there no market for the large quantities of pre-crushed materials you have on stockpile? Process these materials with Pfeiffer grinding plants to obtain high-quality fillers! Energy efficient and reliable. The economical solution for generating additional benefit - we will be happy to advise you.

» By the way:

Each single Pfeiffer equipment is also available as a fully functional stand-alone solution.

Drying and classifying to obtain crushed sand and filler aggregates

// Lumpy mineral materials are dried in Pfeiffer Triplex dryers, dedusted in Pfeiffer classifiers and separated into crushed sands (0 - 0.5 mm to 0 - 4 mm) in screening machines. Mineral filler is produced as a coupled product. The crushed sand produced this way is primarily used in the building materials industry, filler for road construction.

Mineral sands and fillers

// The dried product can be dedusted in downstream Pfeiffer distribution table air separators and separated in screening machines into sands (0.1 - 1.5 mm) and powder. Sands are primarily used for the production of building materials, powder is primarily used as filler aggregate or for flue gas desulphurization.

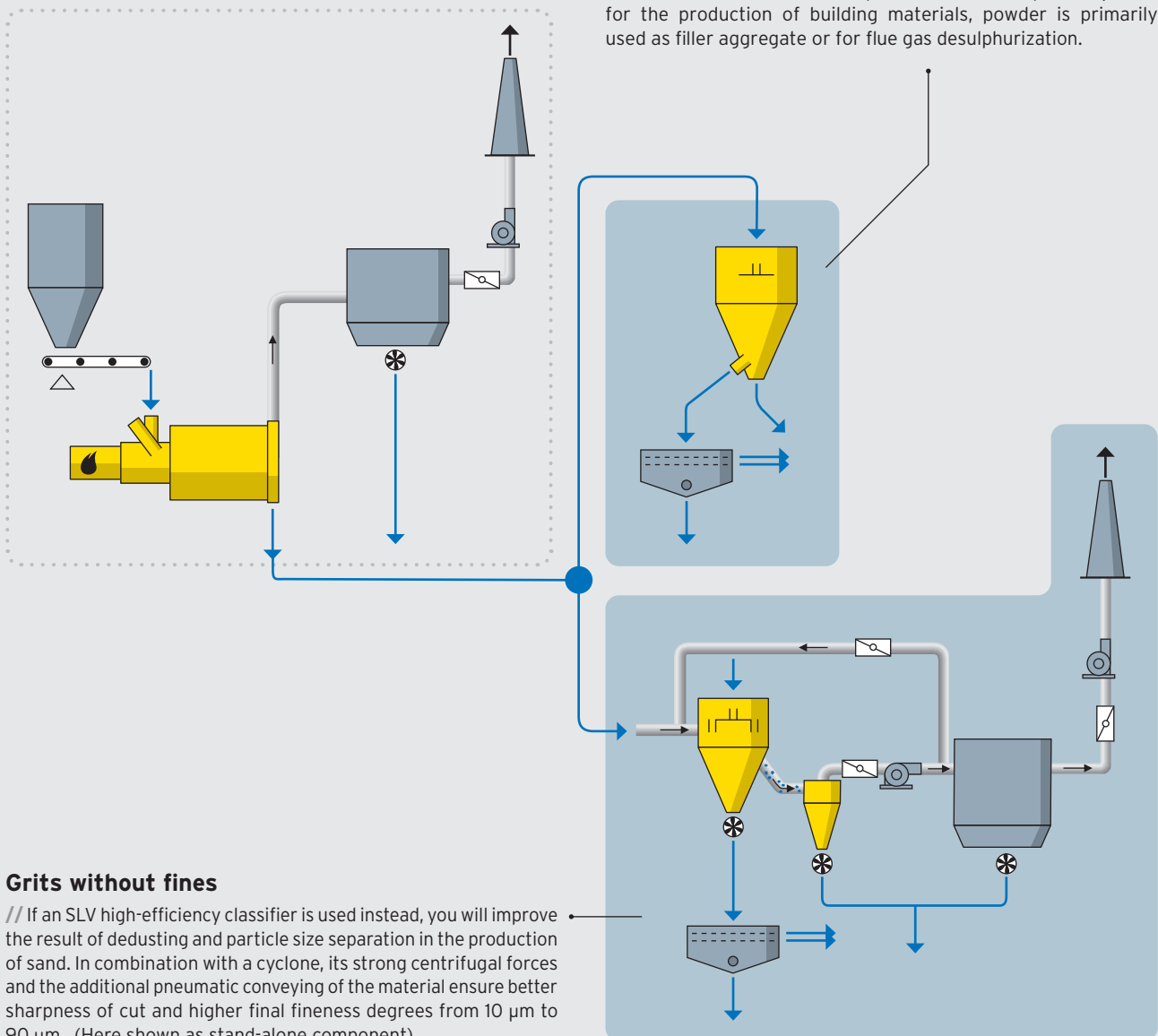

Grits without fines

// If an SLV high-efficiency classifier is used instead, you will improve the result of dedusting and particle size separation in the production of sand. In combination with a cyclone, its strong centrifugal forces and the additional pneumatic conveying of the material ensure better sharpness of cut and higher final fineness degrees from 10 μm to 90 μm . (Here shown as stand-alone component)

» Calcined lime products - products which are guaranteed finish, no post-maturing

// Here, too, the focus is on consulting: You tell us which material you have and which product you can sell well. We make hydration tests with your raw material, determine where the possibilities lie and what we can make of it. Is it suitable for an ultra-fine product? Is it worthwhile to have to end products? Is it possible to get more out of it? How can a better quicklime quality be achieved? We ask all the important questions, show you how to achieve the best result in the most efficient way - and supply the machines, the knowledge and the service for it.

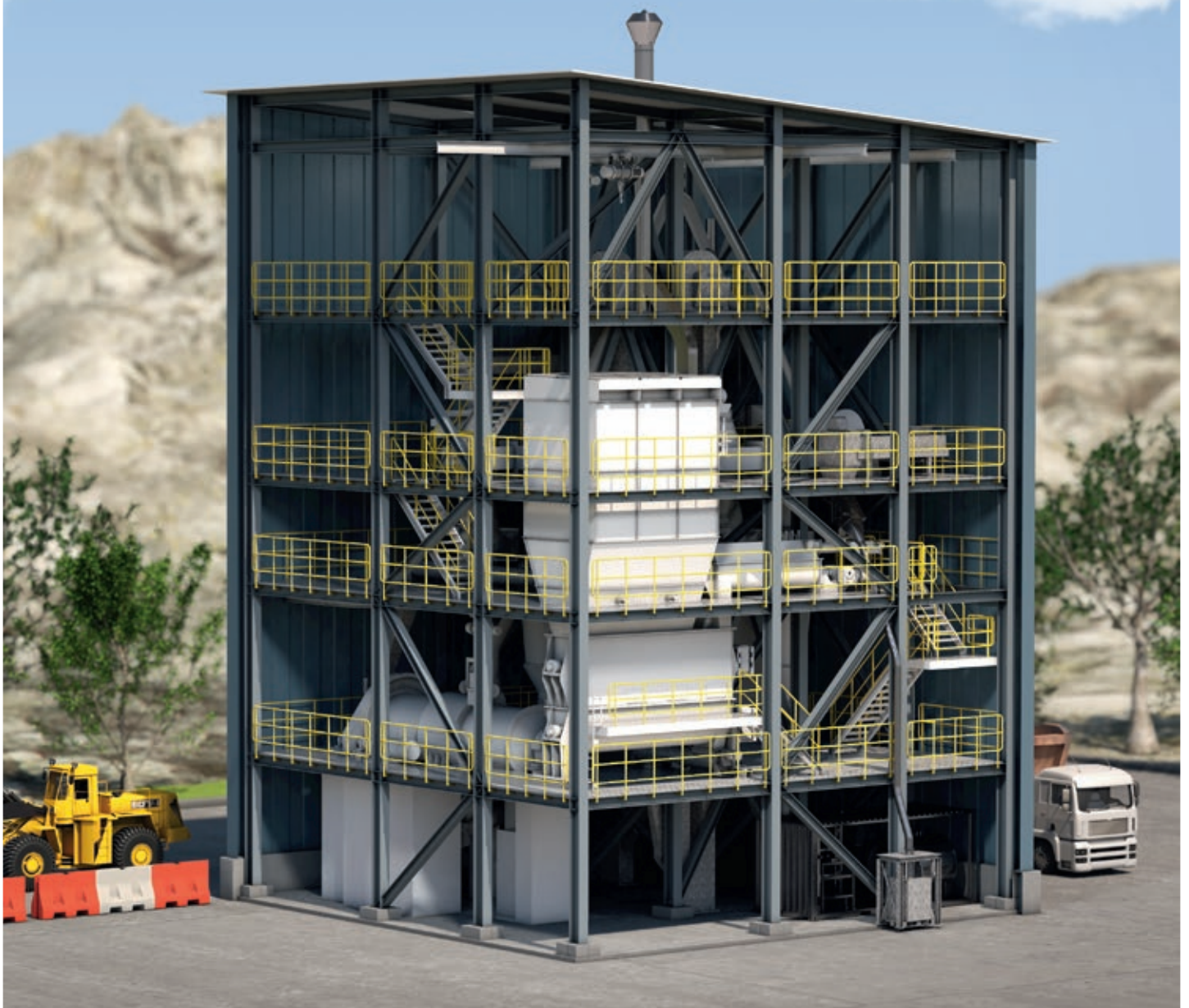



Complex plants or individual components

// For burnt lime products, Pfeiffer supplies complete plants or vertical roller mills, separators, lime hydrators and ball mills for lime hydrate grinding as individual components. Always in outstanding Pfeiffer quality. And always with special Pfeiffer service.



Flexible lime hydration guarantees products to be free of reactive components

// Thanks to their sufficiently long hydrating process, Pfeiffer lime hydrators can be used for soft, medium, or hard burned lime. They safely and reliably hydrate the material completely and deliver a finished product with a final moisture content of less than 1 %. No maturing silos required, no time for maturing required - and the product is guaranteed to be free of reactive components.



The most efficient solution

// By integrating a vertical roller mill into your process, you benefit from all the what makes modern vertical roller mill technology so efficient. Thanks to their comminution principle the electrical energy consumption is for example by up to 40 % lower compared to ball mills. Ask our experts!



Determine the characteristics of your product

// In our lime hydrator, you can influence product properties, such as the specific surface area, and thus produce exactly the hydrated lime you need for your customers and markets.



Use Pfeiffer equipment to produce:

- » Fine white lime
- » Hydrated lime
- » High-purity hydrated lime
- » Building lime

» Calcined limestone products - find the right process for your product

Grinding and hydrating to obtain fine white lime and hydrated lime

// Quicklime lumps are ground and separated in Pfeiffer MPS vertical roller mills. The fineness of the fine white limes can be set within wide limits (0.06 mm - 0.1 mm). In downstream Pfeiffer lime hydrators quicklime is processed by adding water thereby creating hydrated lime.

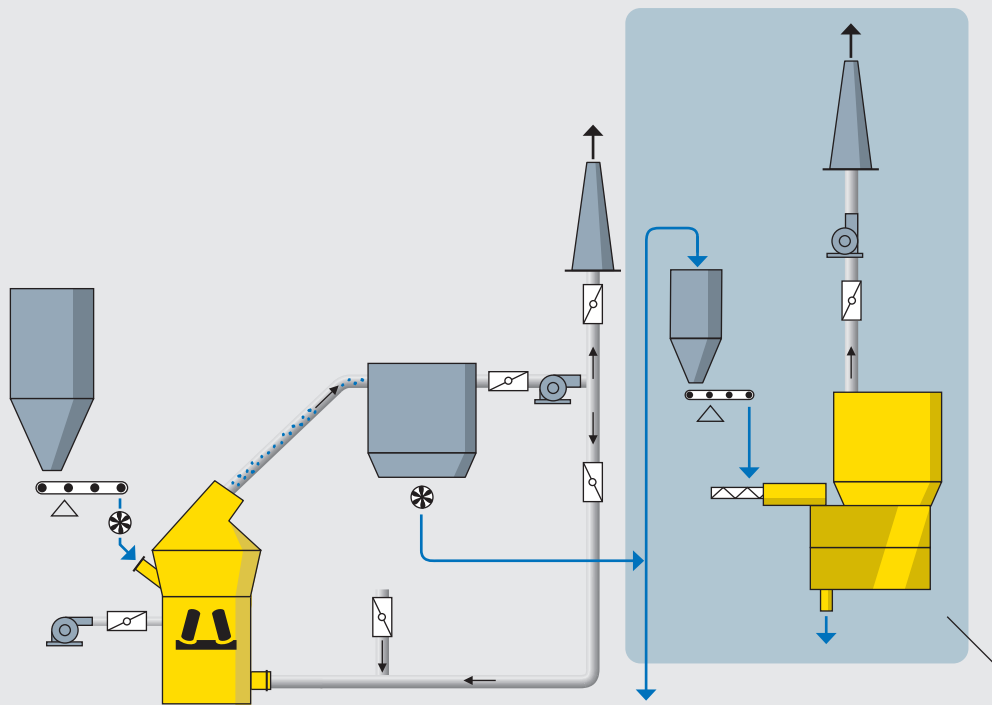

Production of hydrated lime

// In the lime hydrator quicklime fines or quicklime lumps turn into hydrated lime after the controlled addition of water and at defined temperature. The requested residual moisture content of the hydrate is controlled by the process. The lime hydrator can be combined with the vertical roller mill as a 2nd stage or, if required, as a stand-alone solution.

Hydrating and grinding to obtain high-purity hydrated lime and building lime

// In lime hydrators quicklime lumps are converted into hydrated lime by adding water. In downstream Pfeiffer separators high-purity lime hydrate is separated from the grits. The grits are ground to building lime with the required target fineness in ball mills which operate in closed circuits. High-purity hydrated lime is primarily used in the chemical industry and for water conditioning.

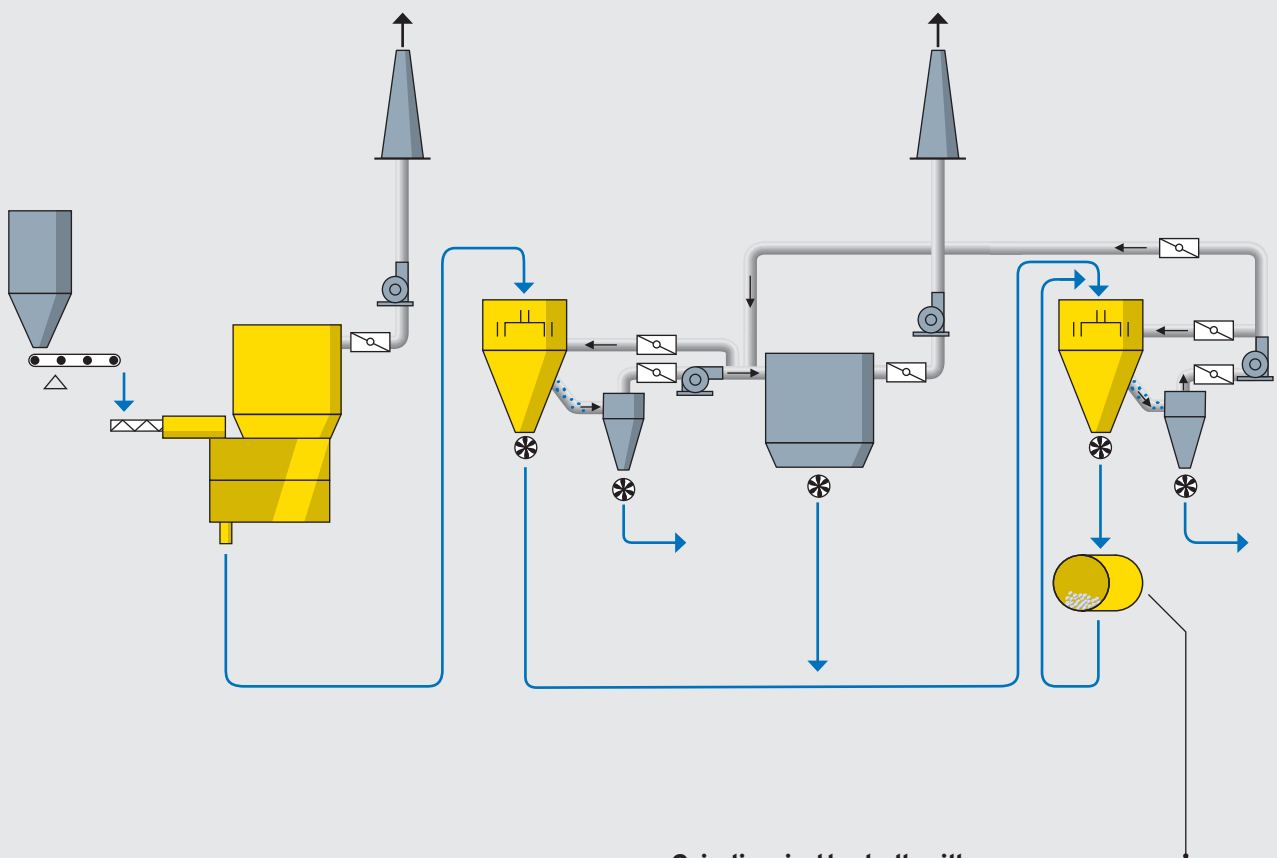

Grinding in the ball mill

// In contrast to quicklime grinding, where the use of a Pfeiffer vertical roller mill is clearly the best choice, a Pfeiffer ball mill is the best solution for grinding hydrated lime. With its simple, robust design and wear-resistant lining, it ensures maximum availability and service life requiring low maintenance requirements. Product fineness and particle size distribution can be varied within a wide range (0.01 - 0.2 mm) by using a high-efficiency separator.

» Pfeiffer vertical roller mill technology - high production rates and flexible in terms of products

// As standard mills for the efficient grinding of different types of minerals, Pfeiffer vertical roller mills meet the highest demands in terms of reliability, energy efficiency and service life. Your central advantage: high production rates with consistent quality - and extremely flexible changes between different fineness degrees or different feed materials within a few minutes. Especially in this area, Pfeiffer vertical roller mills are unbeatable due to their particularly short throughput times. An investment that pays off.

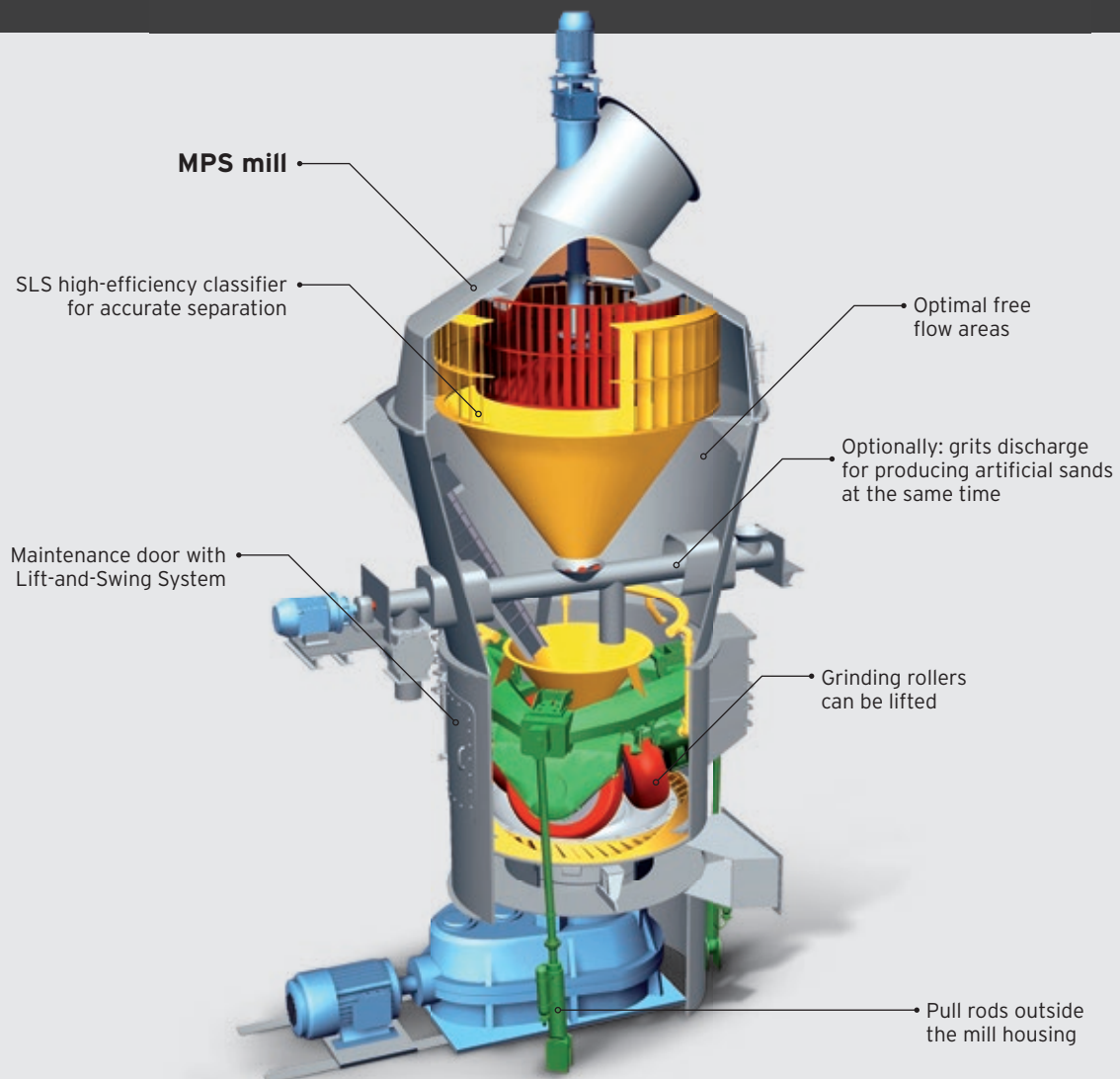

Fully automatic operation

// MPS mills are characterised by a high drying capacity, short dwell time and remote control of important operating parameters such as grinding pressure and speed of separating wheel. The MPS vertical roller mills can be operated fully automatically, even with different varying raw material characteristics.



Your advantages with Pfeiffer vertical roller mills

- » **Low investment costs** - few additional machines, low building volume, dust-free and quiet
- » **High reliability and ease of maintenance** - low wear rates and modern maintenance concepts
- » **Low electric energy consumption** - up to 40 % less than ball mills
- » **Optimum use of process heat** - existing process gases are reused, even at low temperatures
- » **Unrivalled fast change** between different fineness degrees
- » **Smallest and largest production rates** with consistent quality
- » **Ultra-fine dry-grinding** around 10 to 20 μm
- » **The energetically best solution** - proven in worldwide use

Ultra-fine dry-grinding with MVR mills - we make the top cut you want

// If you want to grind an ultra-fine product or need even higher production rates. Thanks to its extremely smooth running and higher specific pressures, the MVR mill achieves product fineness degrees in the range of 10 - 20 μm with a top cut at 40 μm . And its energy efficiency is 30 % higher than the one of conventional grinding equipment. Pfeiffer's answer to the complex requirements of high-class applications.

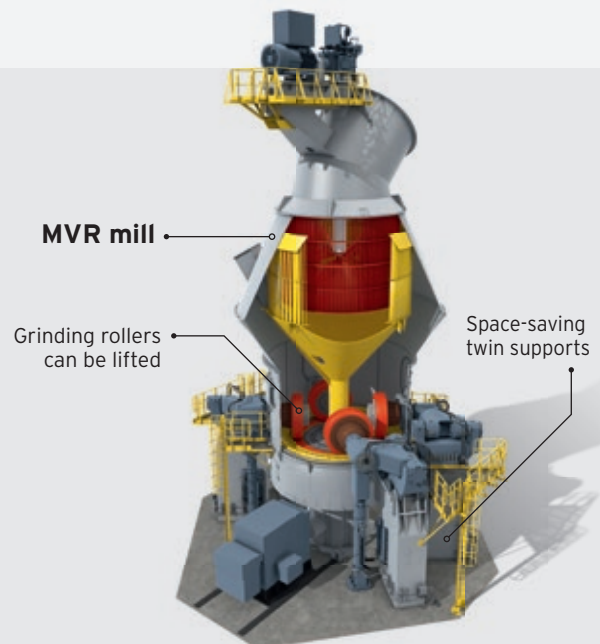

Grain size distributions

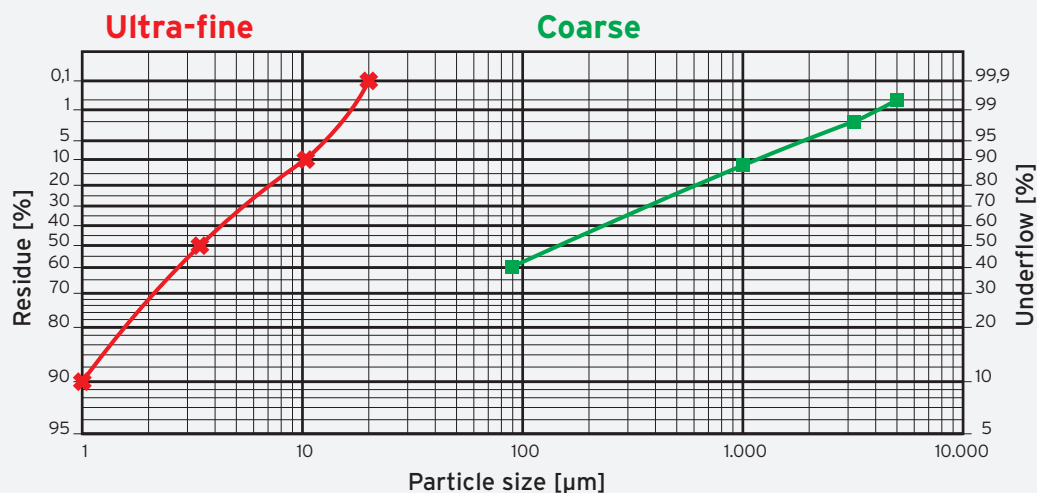

» The tailor-made solution for lime hydration - complete, compact, multi-stage

// Pfeiffer lime hydrators ensure the best hydrate quality for high-quality building lime, lime plaster and chemical lime. And this in the most economical way. We will see to that with many years of experience and concentrated process knowledge. The result: continuously operating drying and hydrating plants, precisely adapted to your very special production conditions.

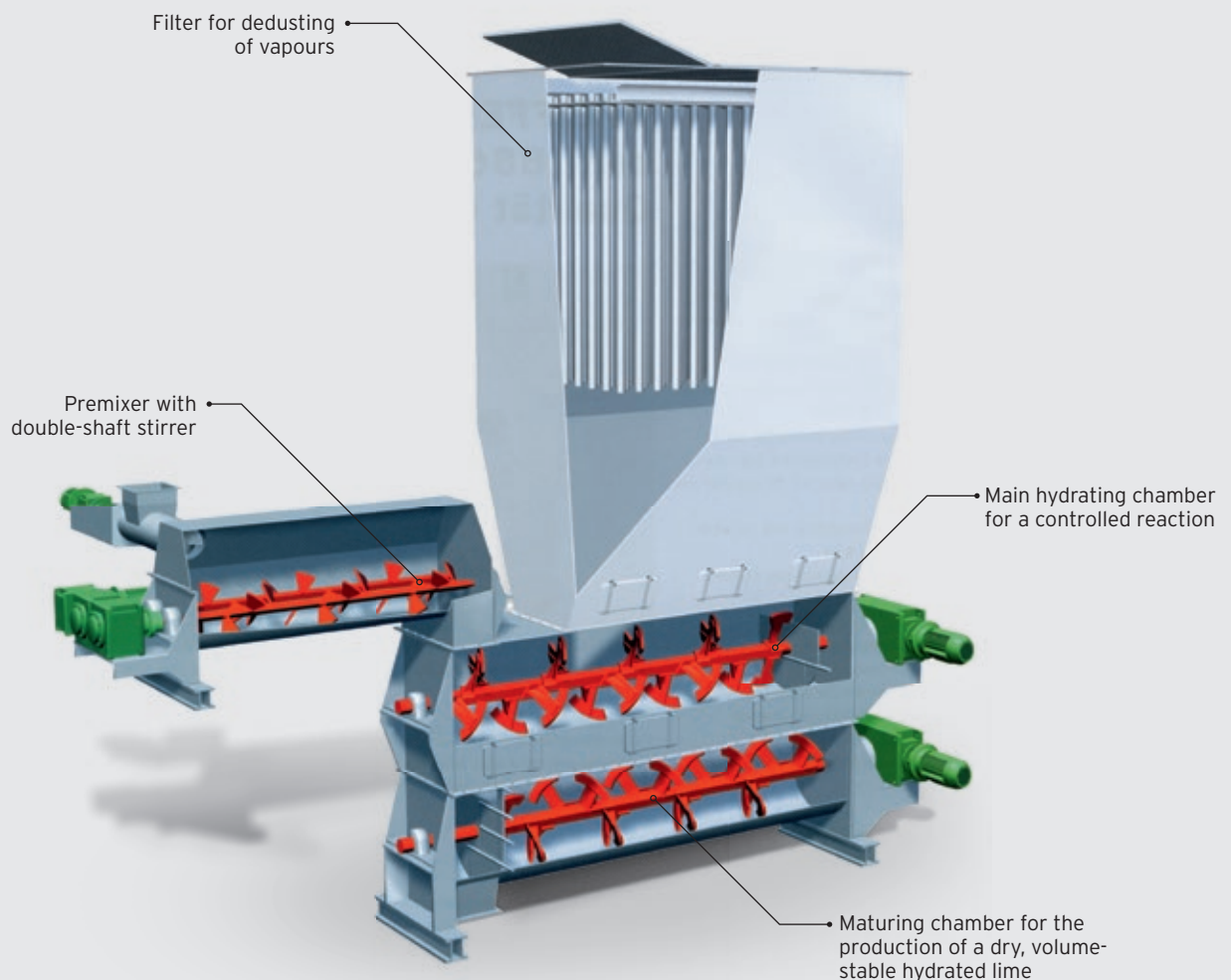

Complete, compact, multi-stage: Pfeiffer's lime hydrator KLV

// Benefit from all the advantages of the Pfeiffer's compact KLV lime hydrator with pre-mixer. The vapours produced during lime hydration are dedusted in the integrated filter - and everything is fully automatic.



Your advantages with Pfeiffer hydrators

- » **The complete three-stage lime hydrator** is a compact unit
- » **High quality and robustness** for highest reliability
- » **Coverage of the entire range:** soft, medium, or hard burned lime
- » **Feed material size 20 mm** or less
- » **Fully automatic operation** with gravimetric quicklime dosing, temperature-controlled water feed
- » **Hydration process completely finished** with guaranteed residual moisture content below 1 % - no maturing silos necessary
- » **Reliable operational safety** for all further processing steps
- » **High content of fines** - few agglomerates

The Pfeiffer solution for quicklime and other products

// Pfeiffer lime hydrators cover the entire range: soft, medium, or hard burned lime. Furthermore, under certain conditions, they can also process other raw materials that need to be converted into calcium hydrate for further processing or landfilling. Calcined ores, converter dust or fly ash from power stations and waste incineration plants - no problem!

How to ensure you get exactly the product quality you need

// The material and water supply to the lime hydrator can be finely adjusted to suit the individual quicklime properties and guarantees the production of a completely hydrated finished product with a low residual moisture content, a high portion of fines and a low portion of agglomerates. The special plus: If you need it for special applications, it is possible to produce hydrates with humidity contents of 25 - 30 % in a targeted manner.

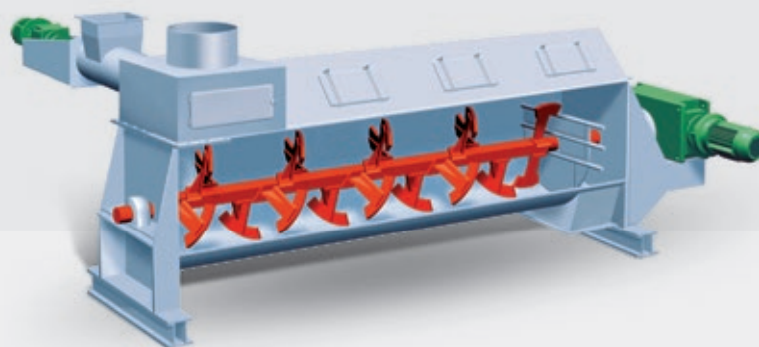

The right lime hydrator for use in power station

// We have developed the single-stage Pfeiffer lime hydrator KLE especially for the production of hydrated lime for flue gas desulphurisation in power stations or waste incineration plants.

» Pfeiffer dryers and separators - consistent development

// Dryers from Gebr. Pfeiffer ensure the right solution for every drying task with particularly low energy consumption. And our versatile, continuously developed separators ensure optimum material distribution with high sharpness of cut. In combination with grinding plants, in a single pass or as a stand-alone solution, they are specially optimised for producing the products required by the market. And form an important part of the Pfeiffer solution.

Drying with lowest energy consumption

// We are specialists in drying - and have been for many decades. Your advantage: the right solution for every drying problem. The core element is always the Pfeiffer TRT Triplex dryer, which has been proven worldwide. It ensures constantly high performance at extremely low energy costs. Exactly what you need.

- » **The material is treated with care.** Thanks to the co-current flow principle, it will not overheat
- » **Particularly low thermal energy consumption** due to the small dryer surface generating low radiation loss and due to the co-current flow principle
- » **Low space requirement** due to three-tube design
- » **Short dryer start-up and shut-down times possible** due to temperature-resistant steel plates instead of ceramic lining

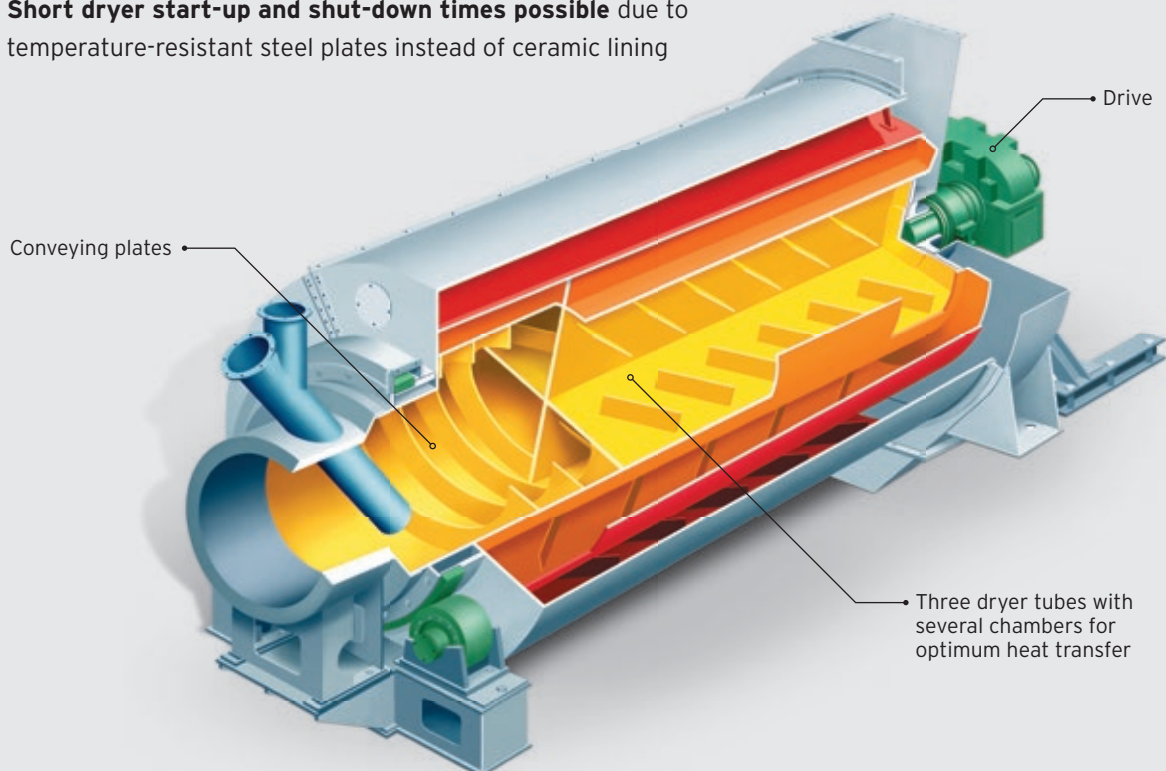

SUV/SUT distribution table air separators

// offer high production rates and sharpness of cut for separation sizes down to 60 μm . The SUV distribution table air separator has a variable speed and allows fine adjustment at the push of a button, even during operation. Almost identical, though without variable speed, the SUT distribution table air separator is a more cost-efficient option, suitable when fineness degrees rarely change.

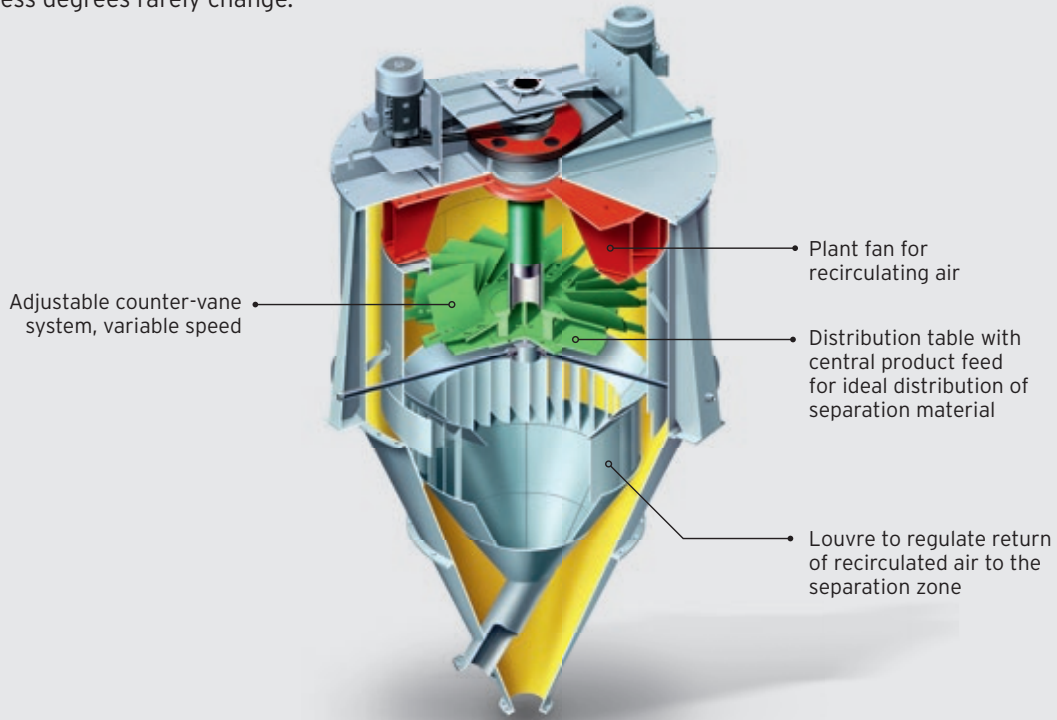

SLV high-efficiency separator

// offers high quality and efficiency, value for money, ultra-accurate separation and fineness degrees down to 10 μm .

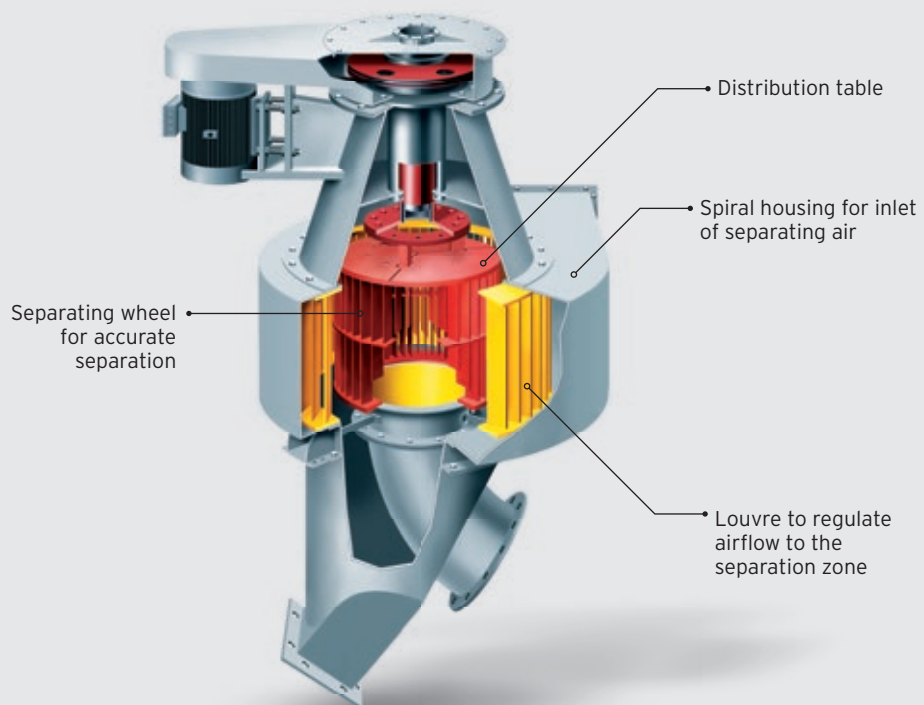

» All products at a glance

» MPS vertical roller mill

Technical data	
Production rate	up to 110 t/h
Mill drive	up to 2,000 kW
Number of grinding rollers	3
Feed grain size	up to 100 mm
Feed moisture content	up to 35 % (surface moisture)
Target fineness degrees	40 - 500 μm
Classifier	High-efficiency separator
Diameter of grinding bowl	up to 4,500 mm
Feed material	lumpy quicklime, limestone and other minerals

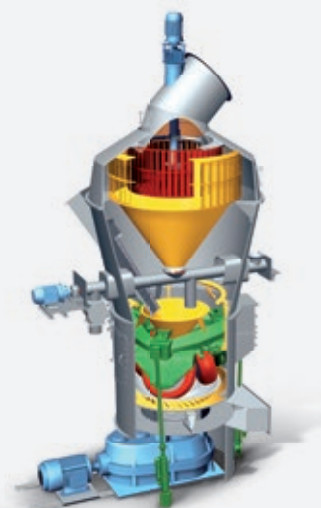

» MVR vertical roller mill

Technical data	
Production rate	up to 650 t/h
Mill drive	up to 6,500 kW
Number of grinding rollers	up to 6
Feed grain size	up to 120 mm
Feed moisture content	up to 20 % (surface moisture)
Target fineness degrees	10-500 μm
Classifier	High-efficiency separator
Diameter of grinding bowl	up to 6.000 mm
Gas volume flow rates	1.500.000 m ³ /h
Feed material	lumpy quicklime, limestone and other minerals

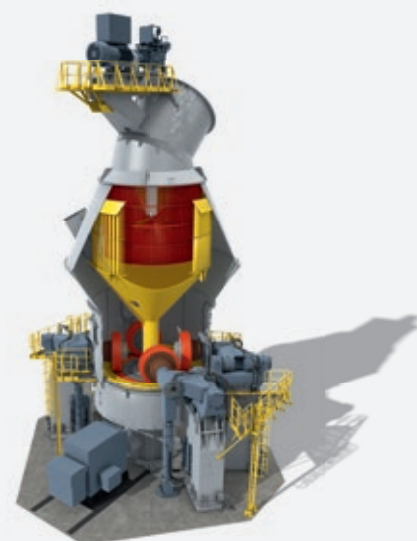

» MRD/MRE ball mills

Technical data	
Production rate	up to 50 t/h
Feed grain size	up to 10 mm
Feed moisture content	dry
Target fineness degrees	10-200 μm
Feed material	hydrated lime

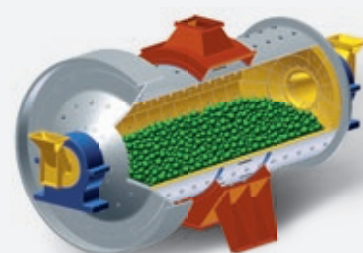

» KLV/KLE lime hydrator

Technical data

Production rate	up to 60 t/h
Feed grain size	up to 20 mm
Finished product moisture content	below 1 %
Feed material	Quicklime (CaO)

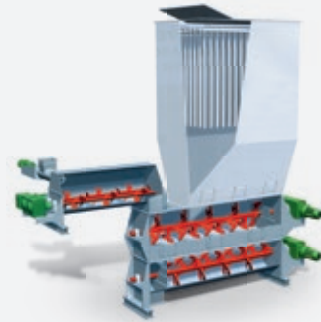

» SLV high-efficiency separator

Technical data

Feed rate	up to 400 t/h
Target fineness degree	up to 10 µm
Feed material	Lumpy quicklime, limestone and other minerals

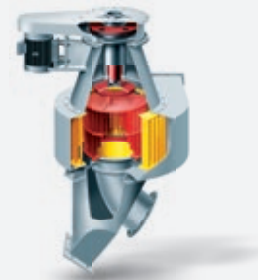

» SUV/SUT distribution table air separators

Technical data

Feed rate	up to 60 t/h
Feed moisture content	dry
Target fineness degree	up to 60 µm
Feed material	Lumpy quicklime, limestone and other minerals

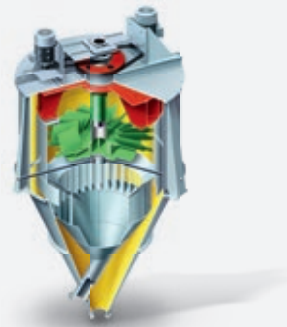

» TRT Triplex dryer

Technical data

Production rate	up to 300 t/h
Feed grain size	up to 150 mm
Feed moisture content	up to 30 % (no slurries)
Drum diameter	up to 5.000 mm
Finished product moisture content	up to 0.1 % H ₂ O
Feed material	Limestone and other minerals

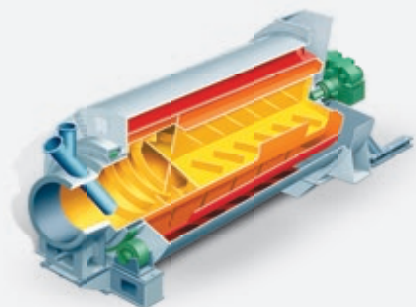

» Excellent service worldwide

// With a dense service network worldwide, Gebr. Pfeiffer offers you partnership-based support throughout the entire life cycle of your machines and plants. Individual, close and committed. From the first consultation until everything runs perfectly and even further. Our experts in all areas react quickly and straightforwardly and also provide short-term decision support. Attractive service contracts and a long-term spare parts supply make sure your investment is secure for decades. That's Pfeiffer service.

» The Pfeiffer services at a glance:

- » Test station/material analysis
- » Expert advice and technical service
- » Installation and commissioning
- » Service contracts, inspection and maintenance
- » Spare parts supply with original spare parts
- » Upgrading and modernization
- » Training sessions
- » Emergency assistance (e. g. in case of production downtimes)

» All details about the Pfeiffer service: www.gebr-pfeiffer.com/service



Special strength: the Pfeiffer test station

// In Pfeiffer's highly specialized test station with realistic test facilities and its own laboratory with state-of-the-art analysis equipment, our experts lay the decisive foundation for optimally coordinated process sequences for each individual Pfeiffer solution.

- » Rating tests and feasibility studies on pilot plants
- » Upgrading and optimizing tests on pilot plants
- » R&D projects on pilot plants
- » Determination of grindability in the lab
- » Physical and chemical material characterization

» Pfeiffer solutions for the mineral industries



Lime hydrating plant in Saudi Arabia including **SLV high-efficiency separator**, **MRD ball mill** and **KLV lime hydrator**



Ultra-fine grinding of limestone in Germany with **MVR 1800 R-4**



Grinding of limestone with **MPS 200 B** in Taiwan



SLV high-efficiency separator

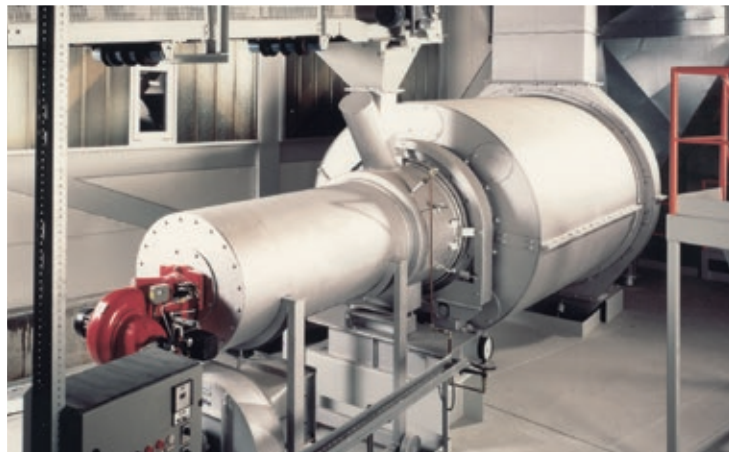

TRT Triplex dryer



Grinding of quicklime with **MPS 200 B** in Bulgaria



Grinding of limestone with **MPS 3350 B** in China



KLV lime hydrator



Gebr. Pfeiffer SE

Barbarossastr. 50-54
67655 Kaiserslautern, Germany
Tel.: +49 631 4161 0
Fax: +49 631 4161 290
headquarters@gebr-pfeiffer.com

Gebr. Pfeiffer USA

Tel.: +1 954 668 2008
americas@gebr-pfeiffer.com

Gebr. Pfeiffer India

Tel.: +91 120 618 8900
india@gebr-pfeiffer.com

Gebr. Pfeiffer China

Tel.: +86 10 65 907 006
china@gebr-pfeiffer.com

Gebr. Pfeiffer Brasil

Tel.: +55 11 3255 2681
brasil@gebr-pfeiffer.com

Gebr. Pfeiffer Egypt

Tel.: +20 103 333 9581
mena@gebr-pfeiffer.com

Gebr. Pfeiffer Malaysia

Tel.: +60 376 224 252
seasia@gebr-pfeiffer.com

Gebr. Pfeiffer Russia

Tel.: +7 495 136 65 98
cis@gebr-pfeiffer.com

